

DH-SD50220I-HC

2 Megapixel Full HD 20x Ultra-high Speed HDCVI PTZ Dome Camera



Features

- 20x optical zoom
- Max 20/30fps@1080P, 50/60fps@720P resolution
- DWDR, Day/Night(ICR), Ultra DNR, Auto iris, Auto focus
- Max 500°/s pan speed, 360° endless pan rotation
- Control over coaxial cable, long distance real-time transmission
- HD and SD switchable
- Up to 300 presets, 5 auto scan, 8 tour, 5 pattern
- Built-in 2/1 alarm in/out
- Support intelligent 3D positioning with DH-SD protocol
- IP67, IK10, OSD

DH-SD50220I-HC

Technical Specifications

Model	DH-SD50220I-HC
Camera	
Image Sensor	1/2.8" Exmor CMOS
Effective Pixels	1920(H) x 1080(V)
Horizontal Resolution	≥1000TVL
Scanning System	Progressive
Electronic Shutter Speed	1/1 ~ 1/30,000s
Min. Illumination	Color: 0.05Lux@F1.4; B/W: 0.005Lux@F1.4;
S/N Ratio	More than 50dB
Resolution	25/30fps@1080P, 25/30/50/60fps@720P
Video Output	1-channel BNC HDCVI high definition video output/ CVBS standard definition video output (Can switch)
Camera Features	
Day/Night	Auto(ICR) / Color / B/W
Backlight Compensation	BLC / HLC / DWDR (Digital WDR)
White Balance	Auto, ATW, Indoor, Outdoor, Manual
Gain Control	Auto / Manual
Noise Reduction	2D/3D
Privacy Masking	Up to 24 areas
Digital Zoom	16x
Lens	
Focal Length	4.7mm~94mm (20x Optical zoom)
Max Aperture	F1.4~ F2.6
Focus Control	Auto / Manual
FOV-H	H: 54.1° ~ 3.1°
Close Focus Distance	100mm ~ 1000mm
PTZ	
Pan/Tilt Range	Pan: 0° ~ 360° endless; Tilt: -10° ~ 90°, auto flip 180°
Manual Control Speed	Pan: 0.1° ~350° /s; Tilt: 0.1° ~250° /s
Preset Speed	Pan: 500° /s; Tilt: 500° /s
Preset	300(DH-SD), 255(Pelco-P/D)
PTZ Mode	5 Pattern, 8 Tour, Auto Pan, Auto Scan
Speed Setup	Human-oriented focal length/ speed adaptation
Power up Action	Auto restore to previous PTZ and lens status after power failure
Idle Motion	Activate Preset/ Scan/ Tour/ Pattern if there is no command in the specified period
Protocol	DH-SD, Pelco-P/D (Auto recognition)
Audio	
Interface	1 channel In
Auxiliary Interface	

DH-SD50220I-HC

RS485	1
Alarm	2/1 channel In/Out
General	
Power Supply	AC24V/ 1.5A
Power Consumption	10W, 19W (Heater on)
Working Environment	-40°C ~ 70°C / Less than 90% RH
Ingress Protection	IP67, IK10
Dimensions	Φ186.0(mm) x 253(mm)
Weight	2.5Kg

Dimensions (mm)

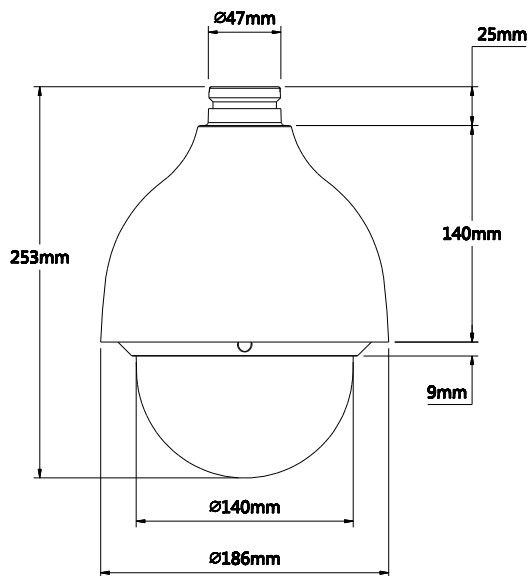







Accessories

DH-PFB300S	DH-PFA110	Power Supply

Accessories (Optional)

DH-SD50220I-HC

		
DH-PFB300C	DH-PFA112	DH-PFA113
		
DH- PFA120	DH-PFA150	DH-PFA151

Dahua Technology Co., Ltd.

1199 BinAn Road, Binjiang District, Hangzhou, China

Tel: +86-571-87688883

Fax: +86-571-87688815

Email: overseas@dahuatech.com

www.dahuasecurity.com

*Design and specifications are subject to change without notice.

© 2014 Dahua Technology